

Twin Divers

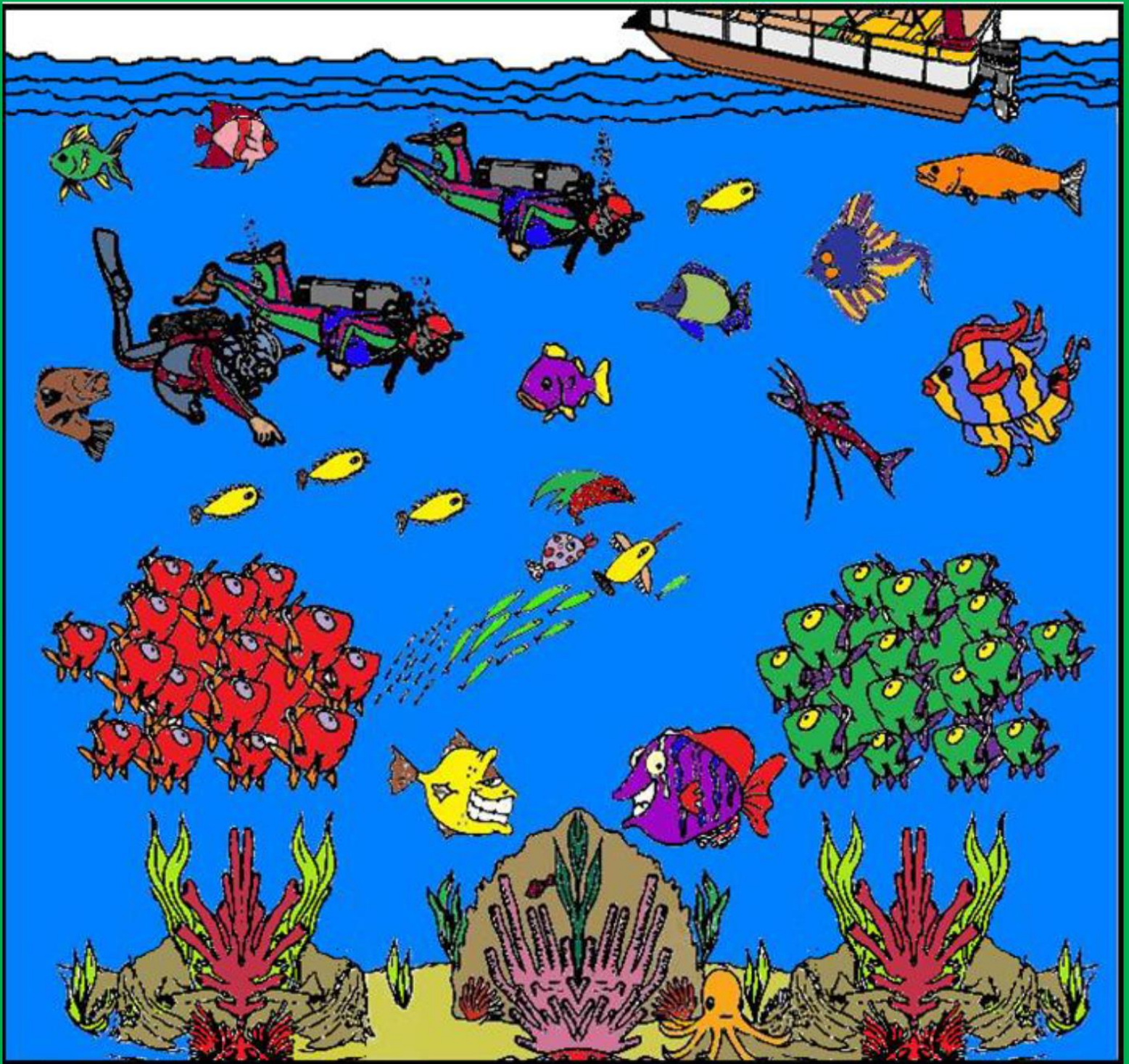

B"H

THE TWIN DIVERS

A FUN BOOK ABOUT UNDERSTANDING MOSHIACH FOR KIDS AND PARENTS



Chaim and Tzvi were identical twin brothers.

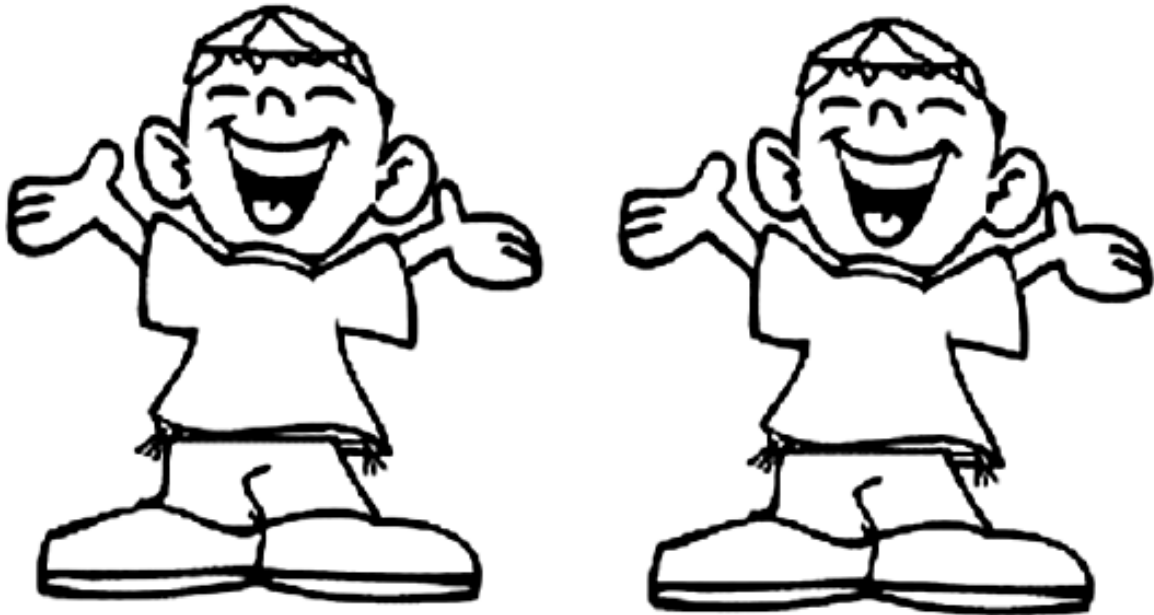

**They were the best team of helpers
the island of Watersplash has ever seen!**

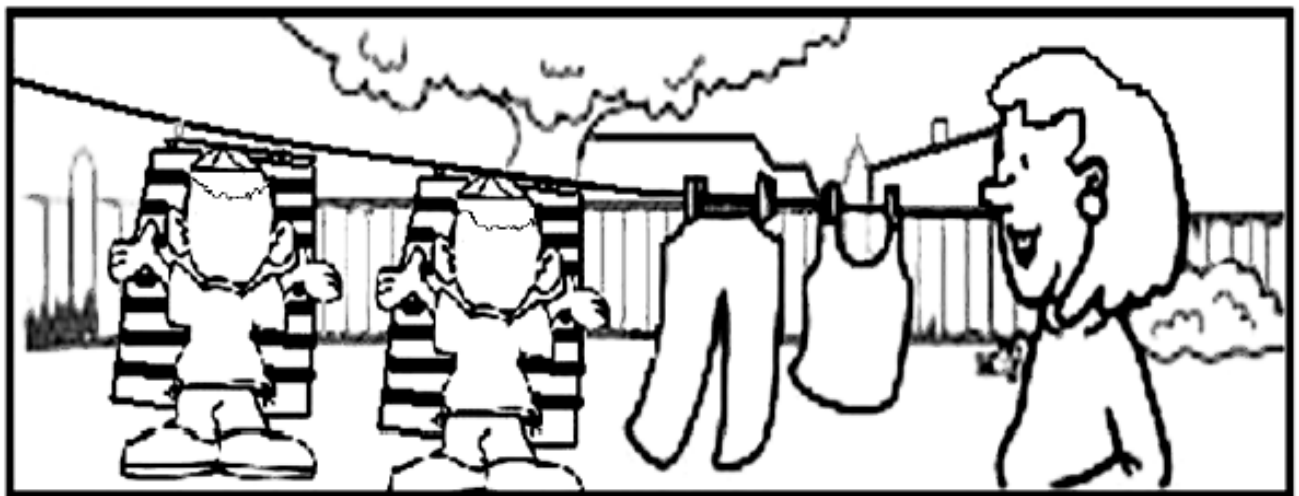



With their sister's Bas Mitzvah just hours away,

Boy did the twins have a crazy busy day!

There were vegetables to be cut and some to be grated,

There were tables to be set and balloons to be inflated.

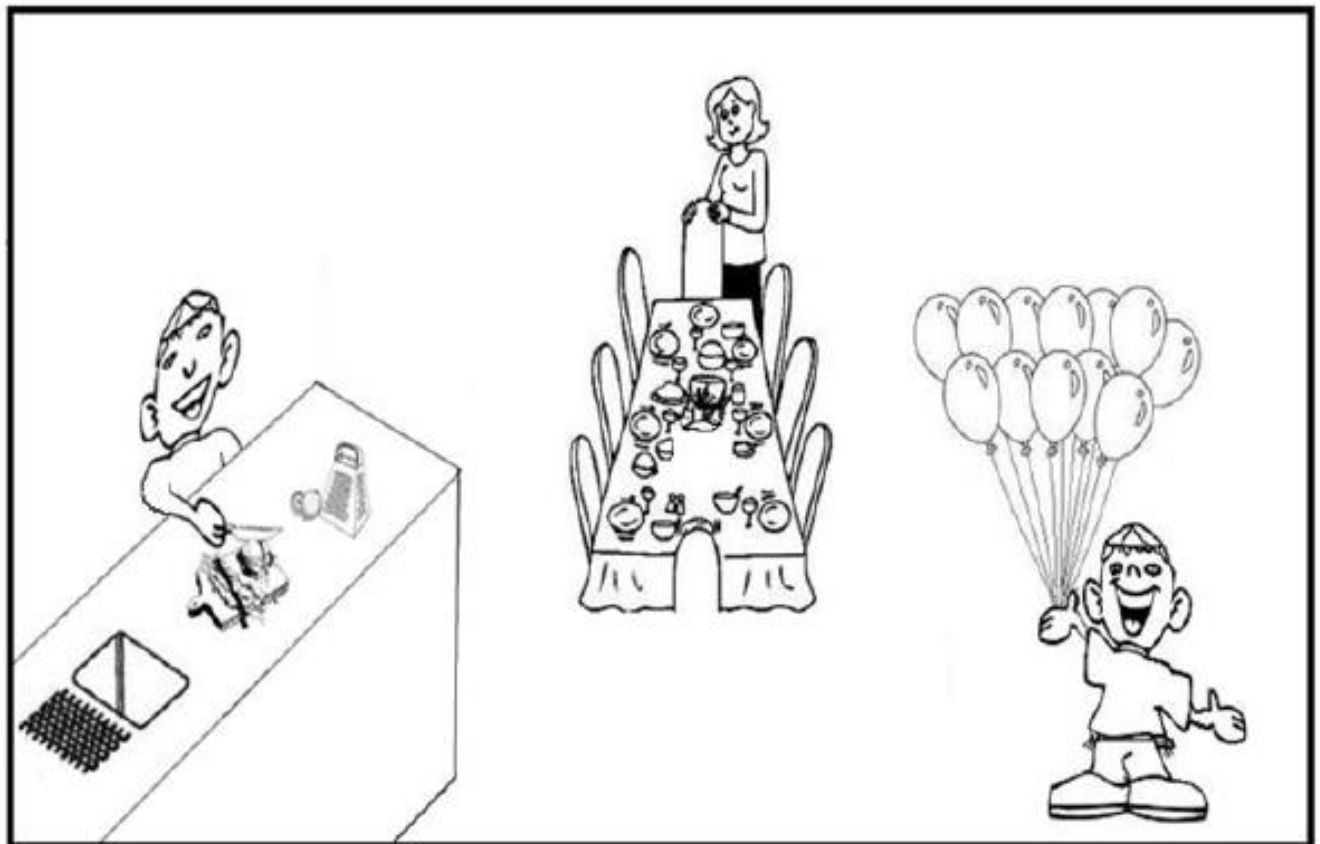

After spending the day setting up the dining room
Tatty promised he'd take them on uncle Yitzy's pontoon.

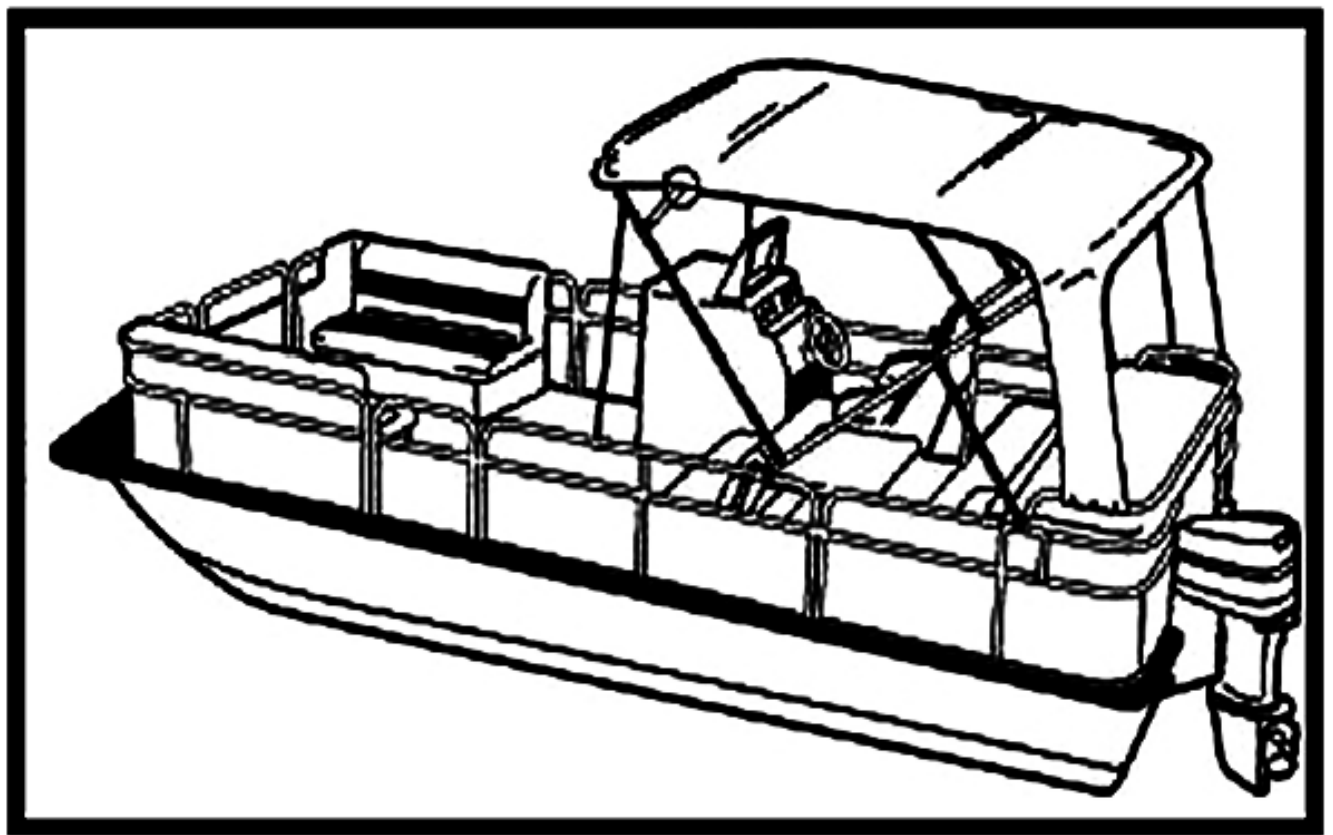

**With a pull and a tug, the engine gave a roar,
Sending splashes of water, on the seats and the floor.
Their little island was looking smaller and smaller,
They were soon surrounded by just waves and water.**

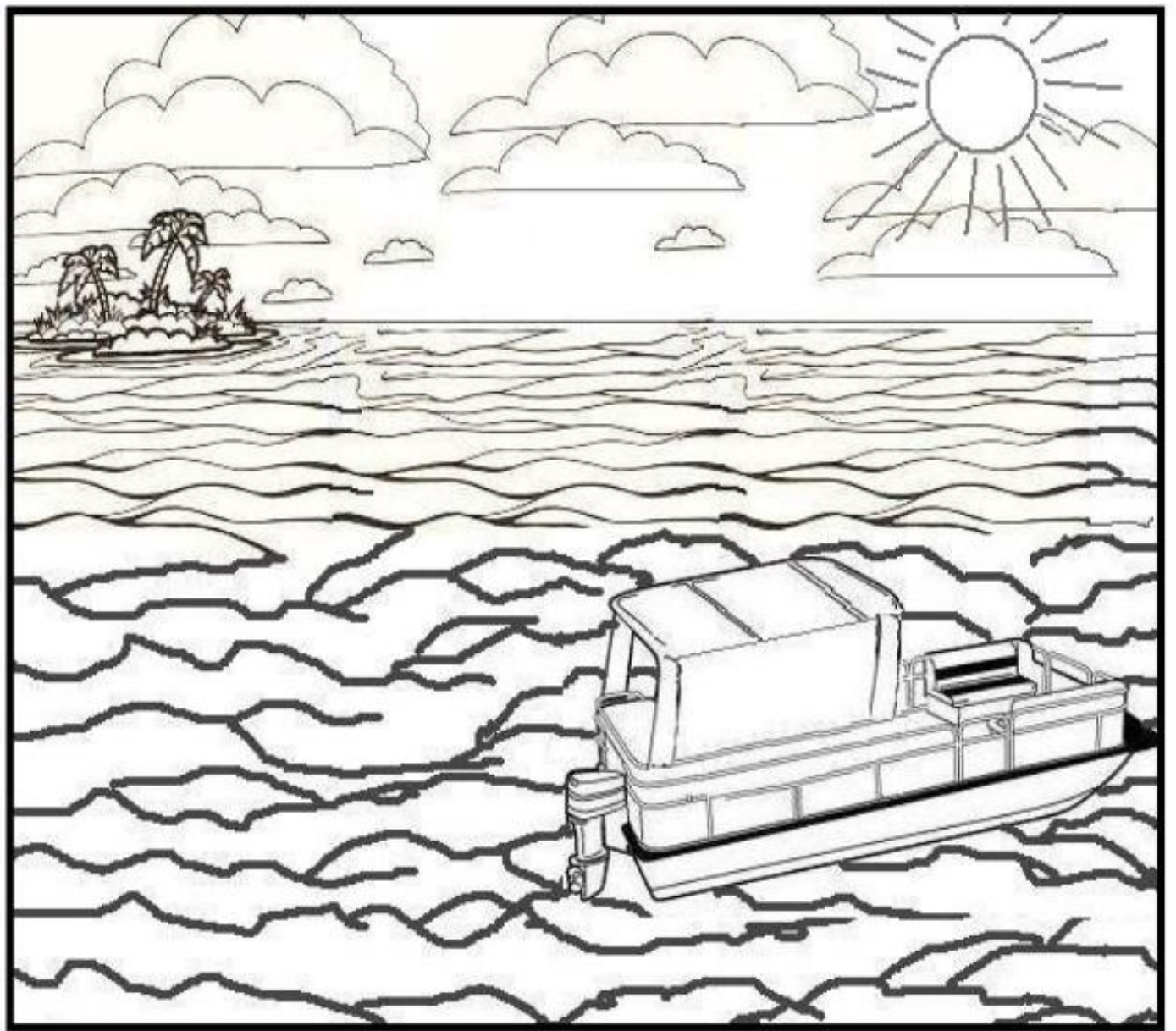

“Were soooooo bored”, cried Chaim and Tzvi,
“This trip is no fun, there’s nothing to see”.

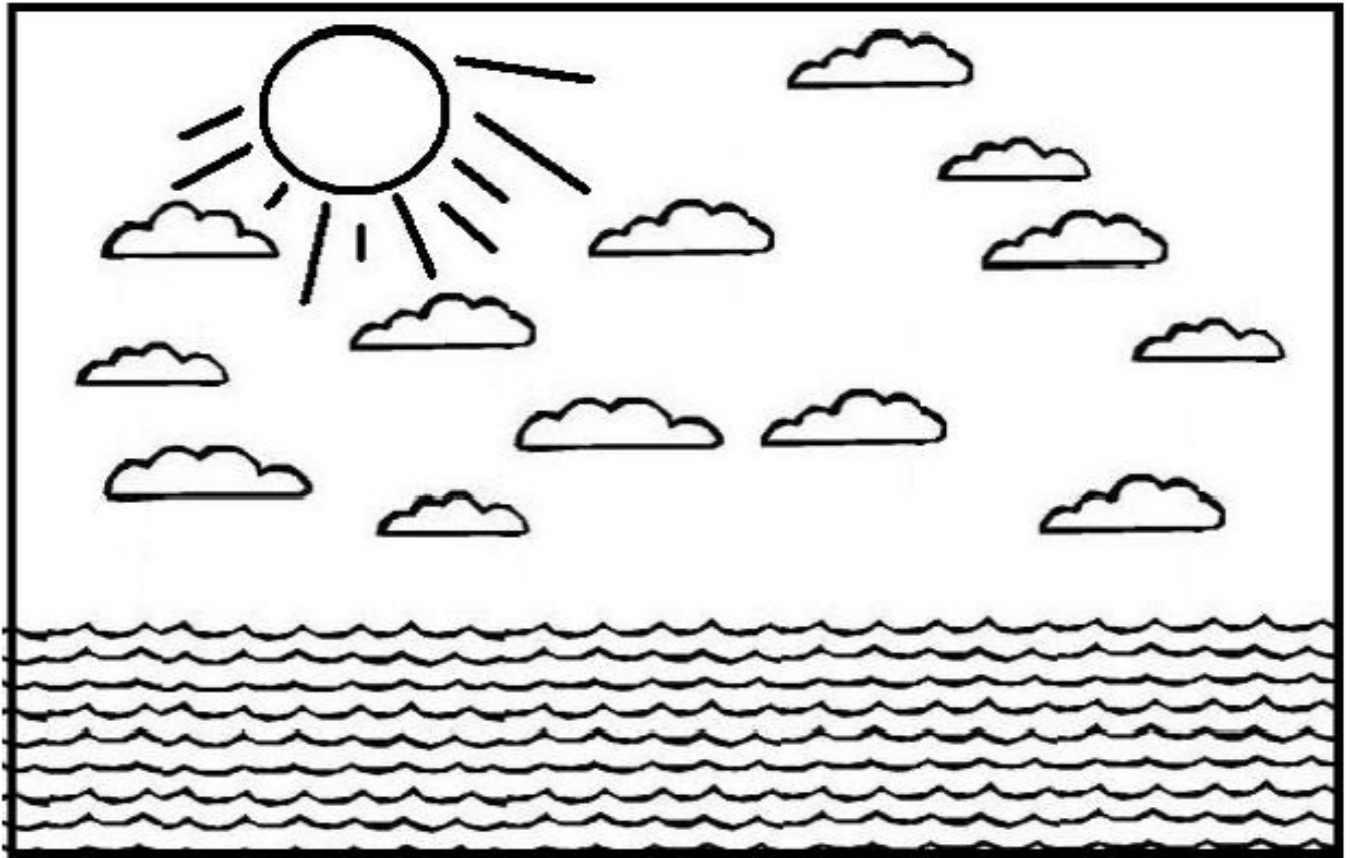

“Come”, said Tatty, “I have a surprise
What I have in this box should open your eyes”.

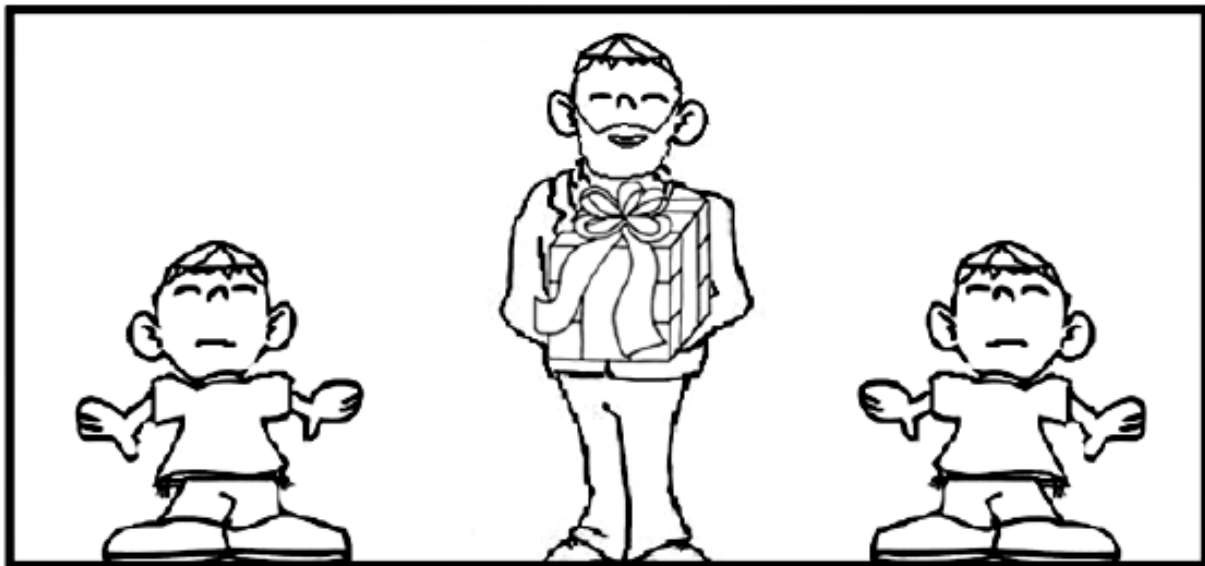

“What’s inside,” wondered Chaim?! “Not glasses, I hope”

“Maybe,” thought Tzvi, “it’s a giant telescope!”

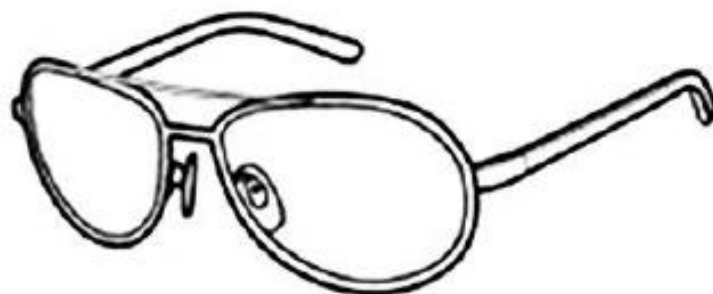

**Tatty opened the box to show what was inside,
The twins were so excited their mouths open wide.
"Wow! Two matching wet-suits with bright orange zippers
Along with a set of goggles and flippers!"**

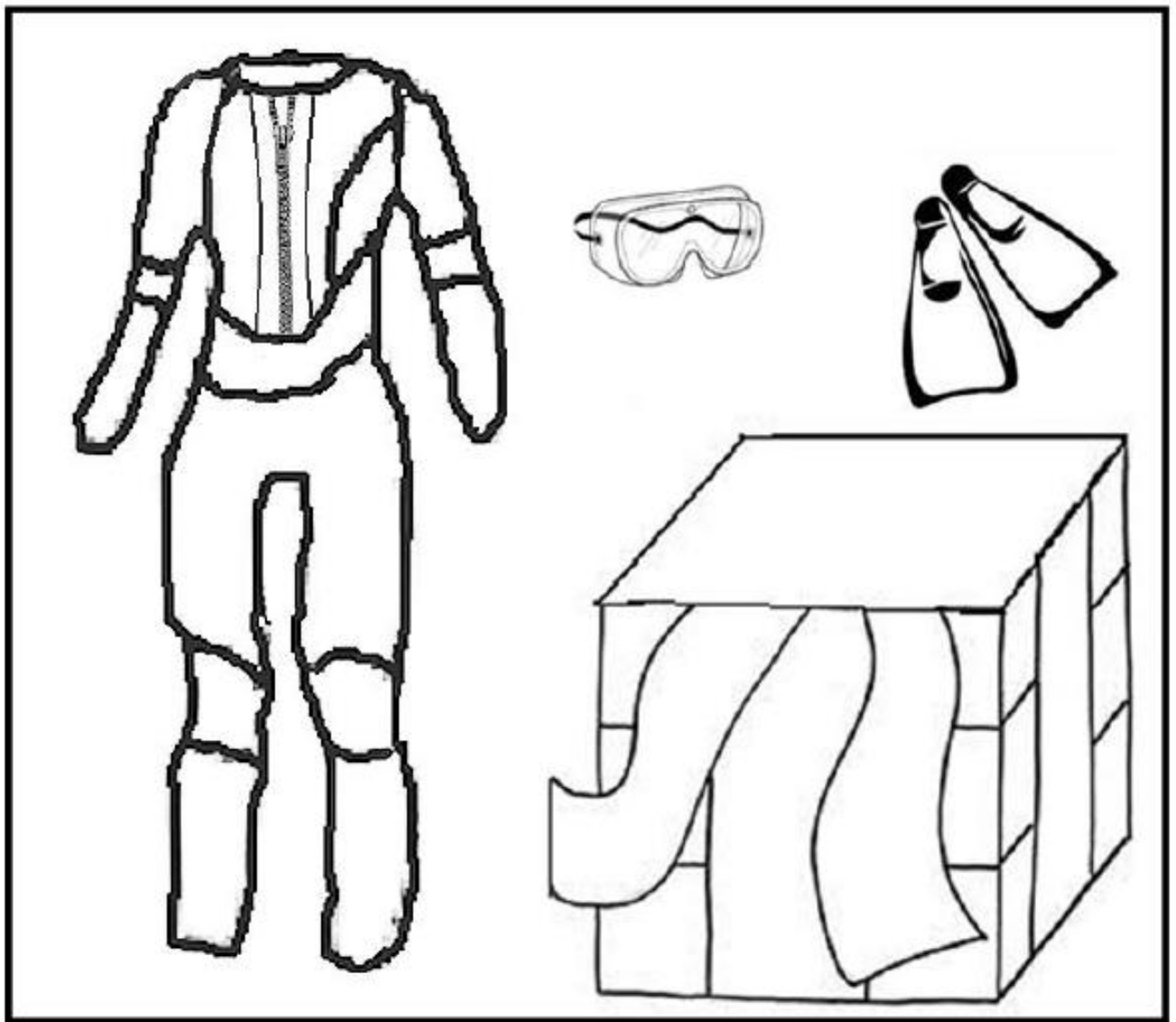

Yay! Scuba diving this was our dream for quite a while”.
“You deserve it”, said Tatty, “for always helping with a smile”.

“But Tatty, who will teach us to be scuba divers?”

“Captain Mo will, he’s one of our drivers”.

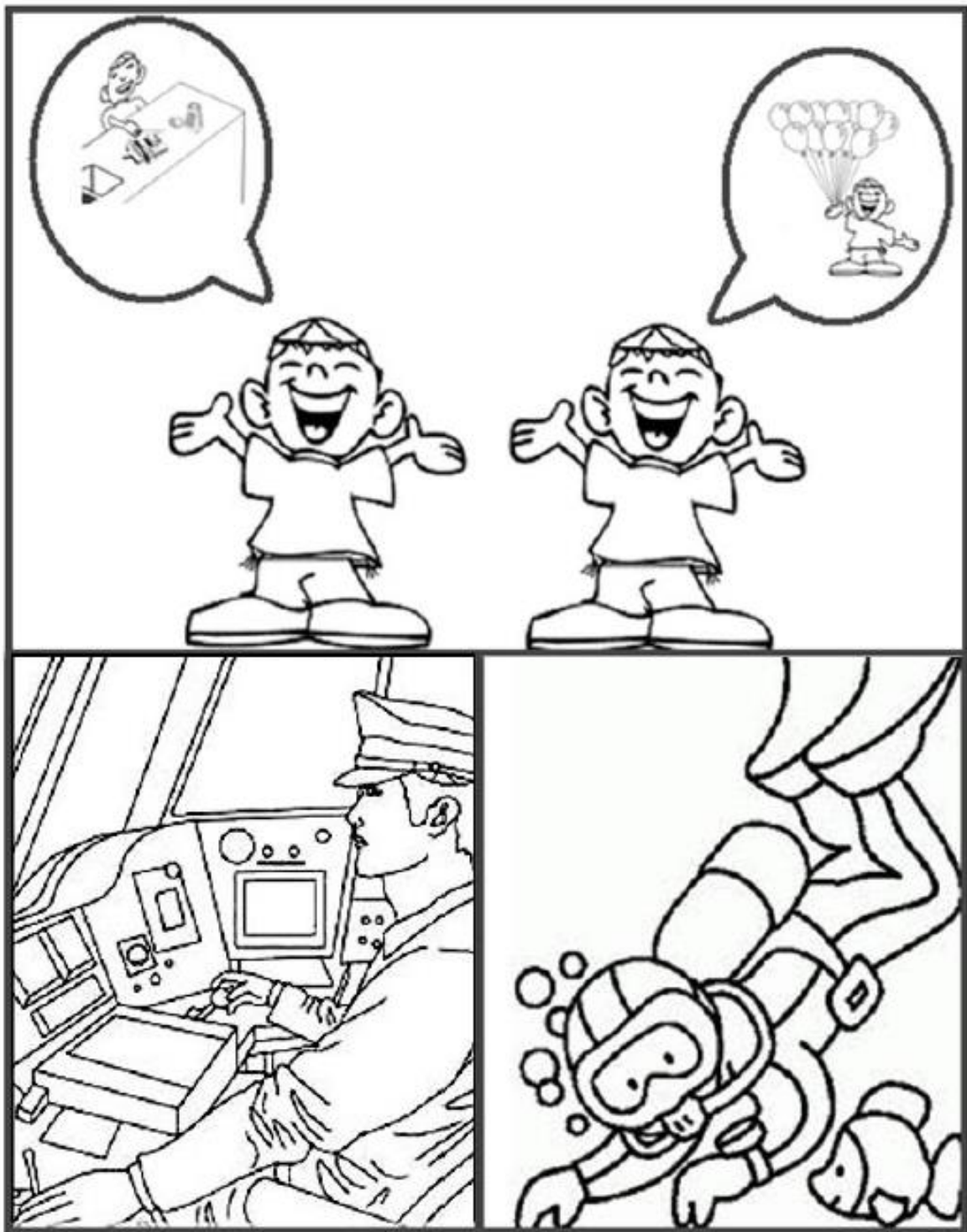

“Get ready,” said Tatty, “you’ll have the time of your lives

You’ll see what I mean this will open your eyes!”

“Ok,” said Captain Mo, “we’ll be under in a flash”

As the three of them dove in, splash, splash, splash.

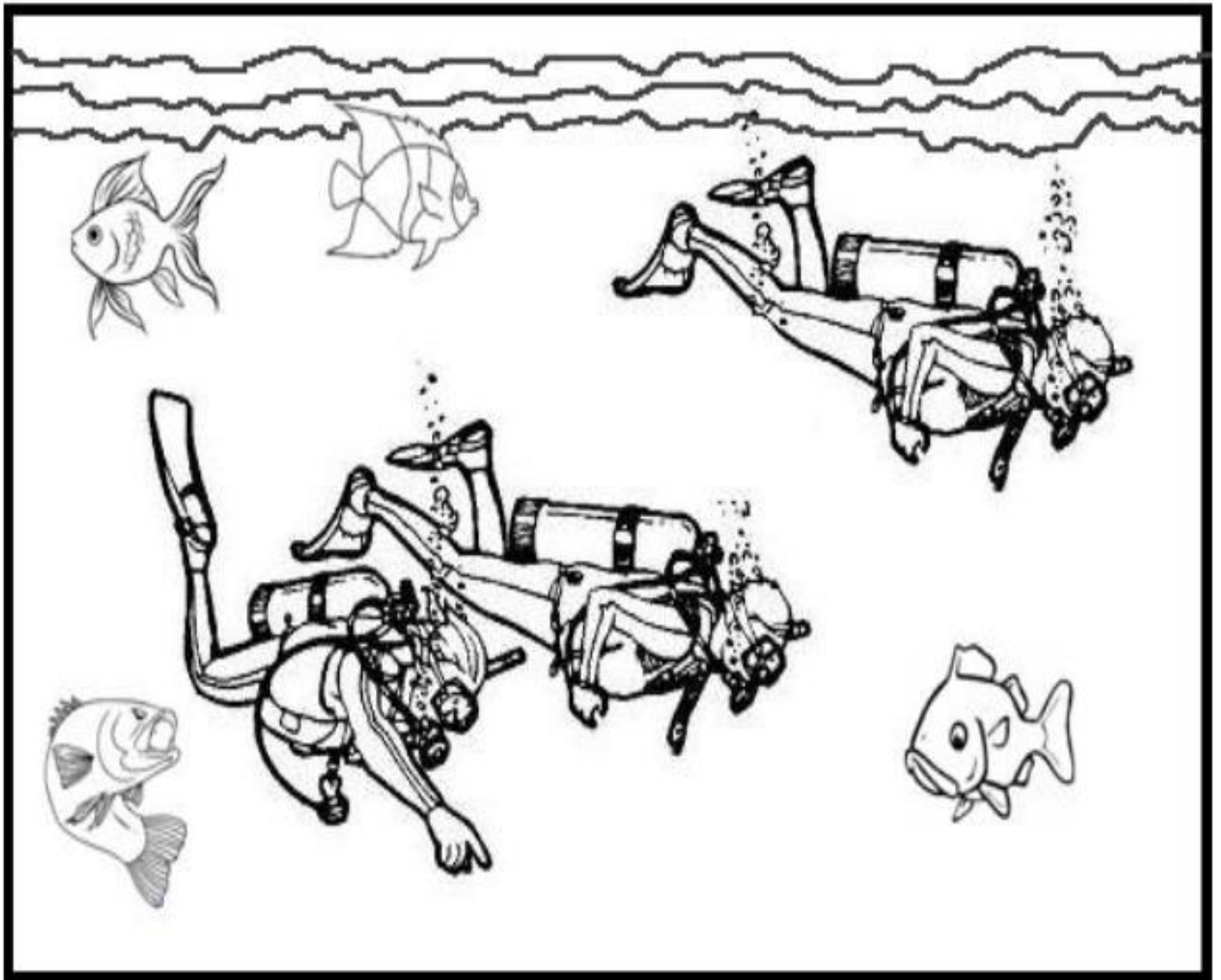

**Under the water a new world could be seen
There were schools of fish, blue, red and green
They saw fish with noses, some even had teeth
They even got a chance to see a coral reef!**

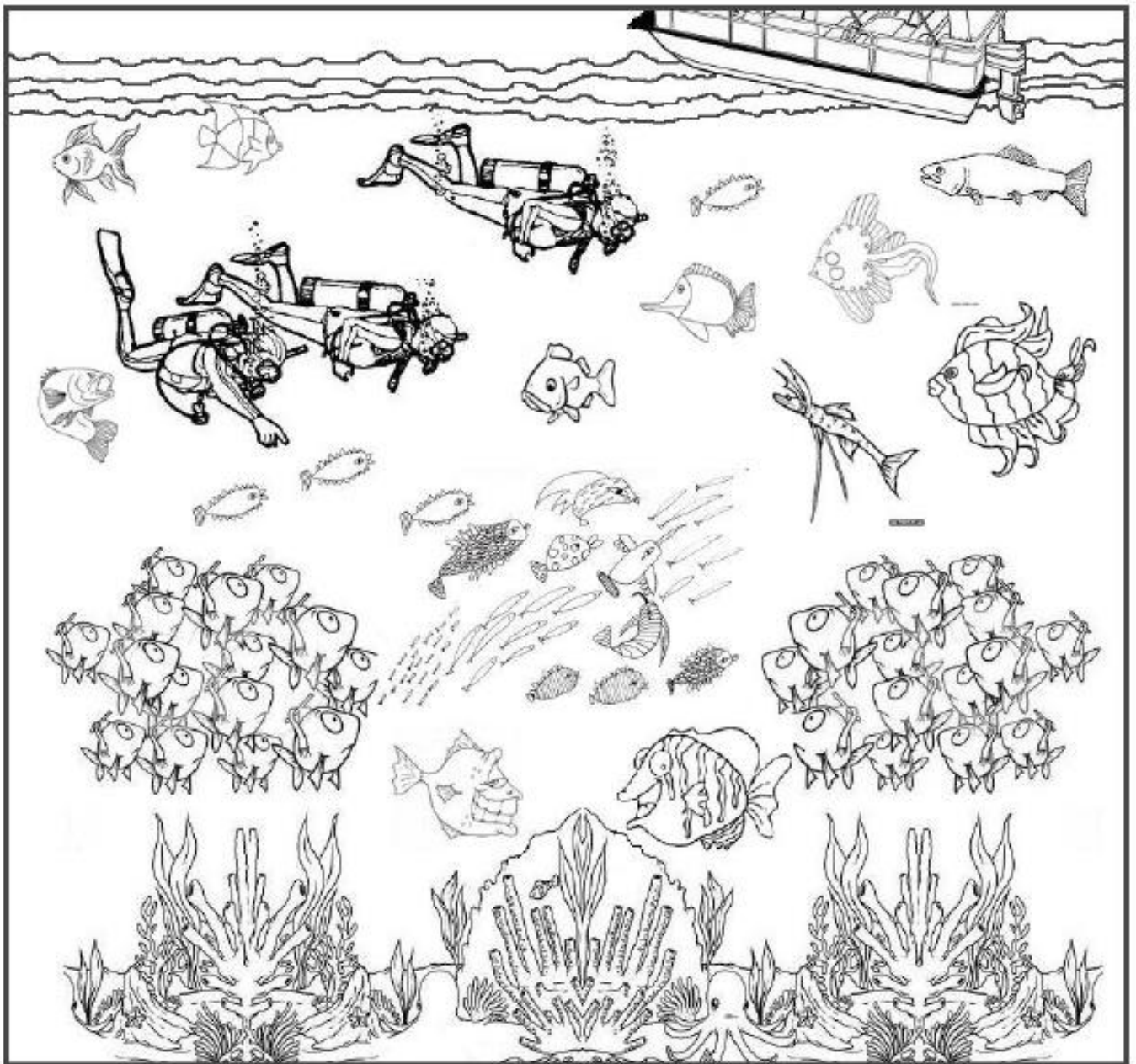

There were fish in all shapes, some swam fast, some swam slow.

Who would ever believe there's a whole world down below?

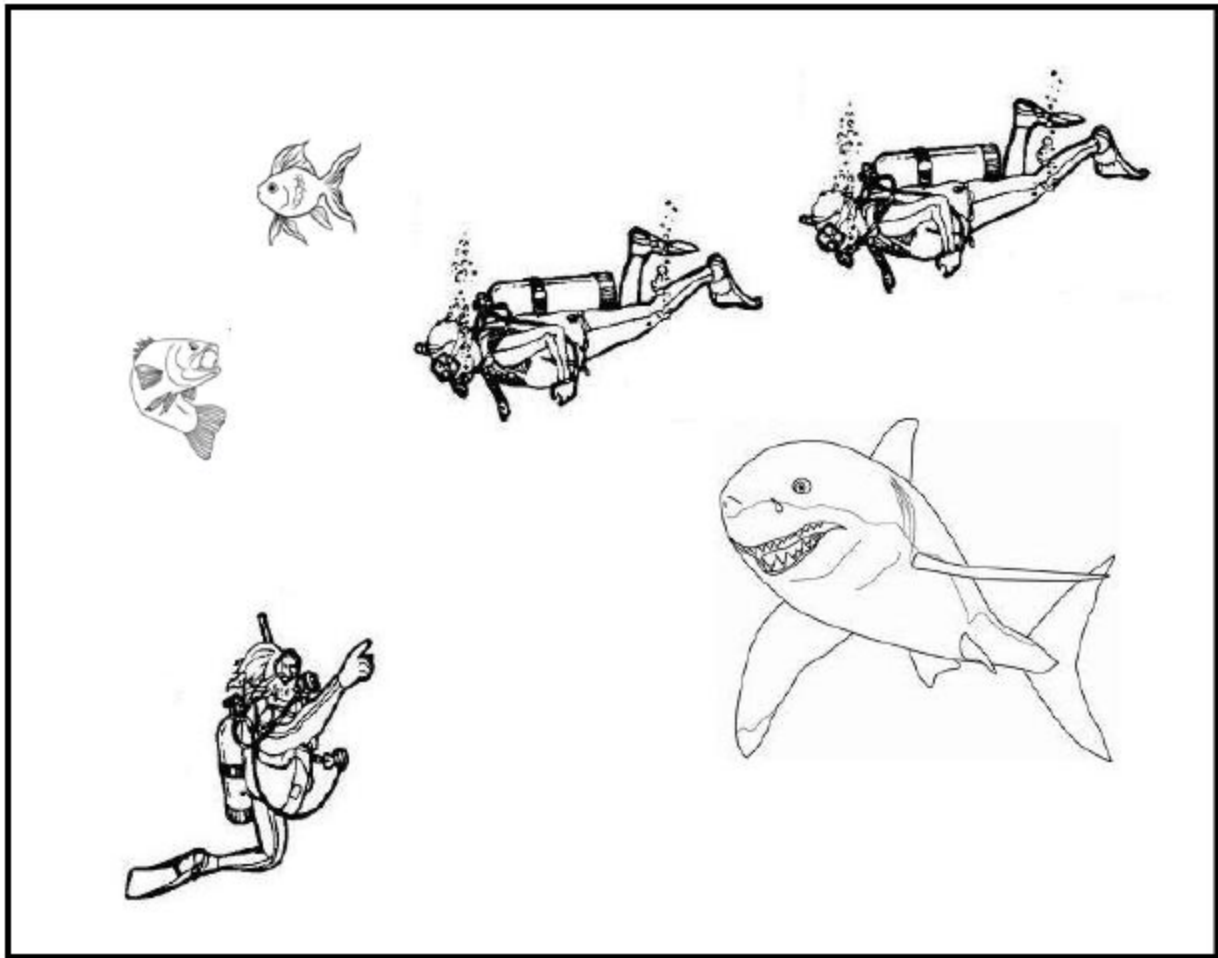

“Ok”, said Captain Mo as they passed a giant shark

“It’s time to go back up, it’s already getting dark.”

They started heading home with the setting of the sun.
“Thanks a million”, said the twins, “that was so much fun.”

Tatty's smile was big as the boat began to turn
“It's more than just fun, there's a lesson we can learn.

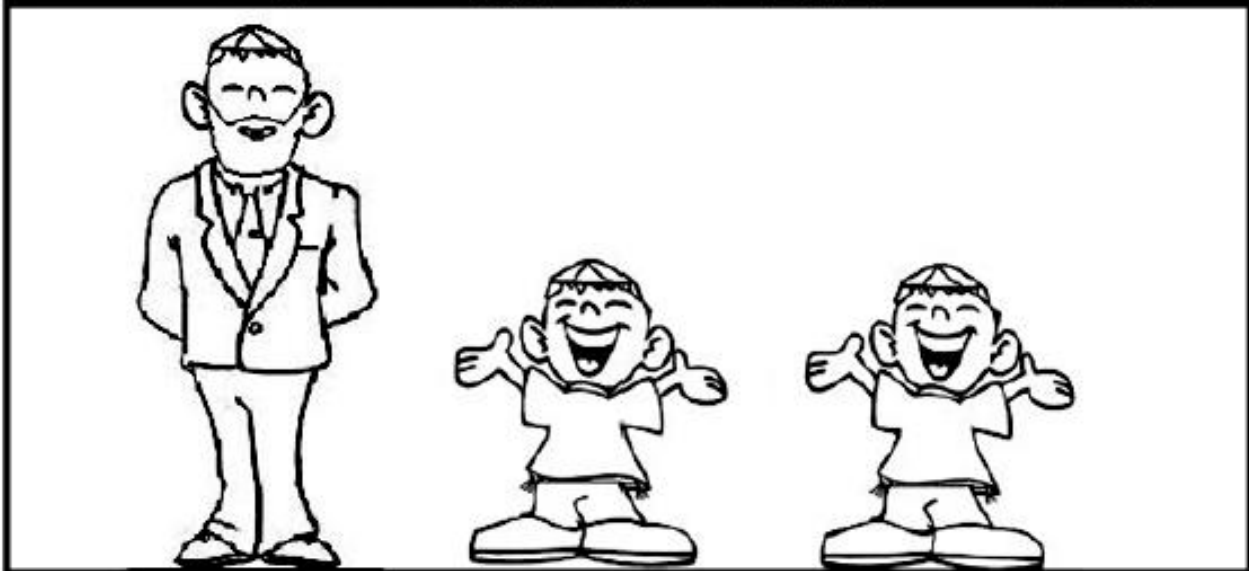
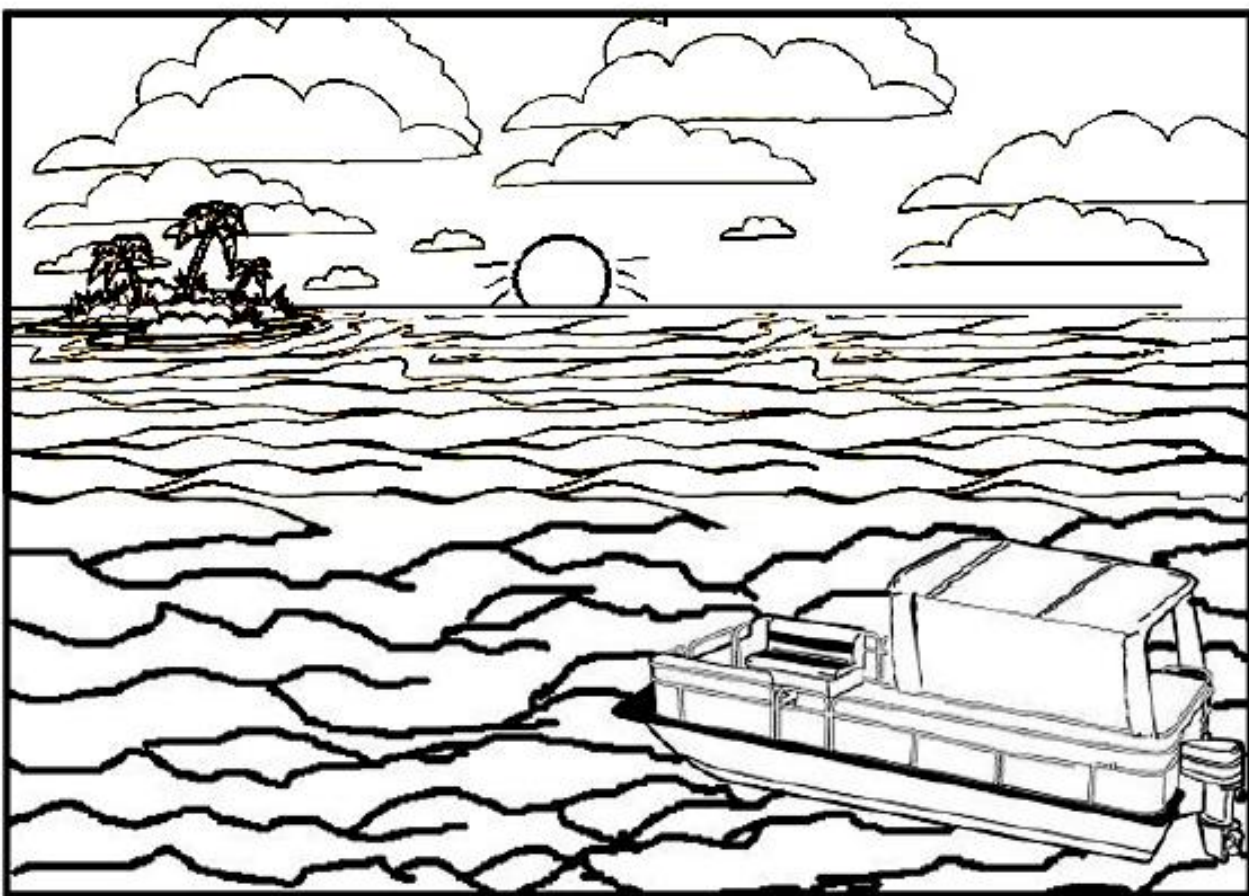

When today's trip started, Chaim and Tzvi,
You both felt so bored and had nothing to see,
But after diving in, I'm sure you both understand,
There's an unseen world below like the one on dry land.

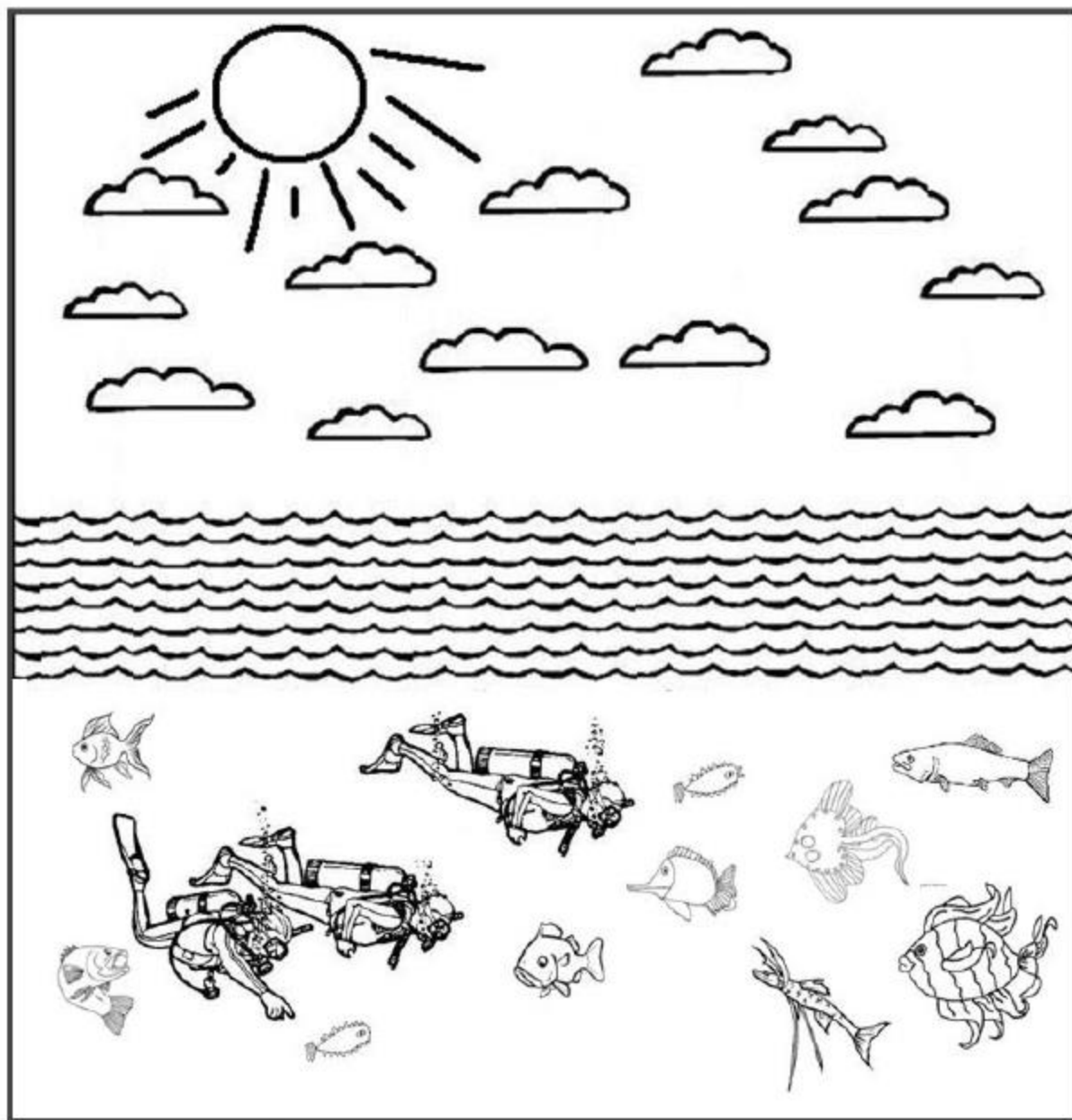

**The same is true for these dark Galus days,
When we can't see Hashem, or understand His hidden ways.**

HASHEM'S HIDDEN MIRACLES IN EVERYDAY LIFE

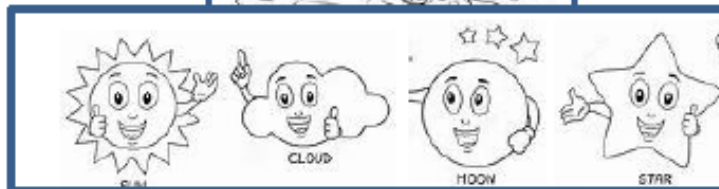

HASHEM'S HIDDEN WAYS THAT WE'LL UNDERSTAND WHEN MOSHIACH COMES

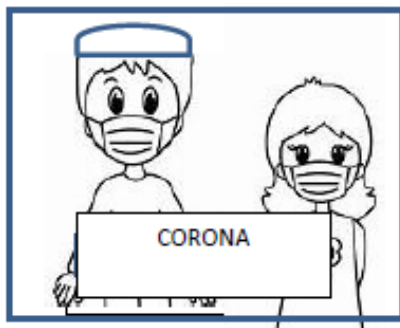

**But when Moshiach will come, the whole world will realize,
That all we had to do is open up our eyes.**

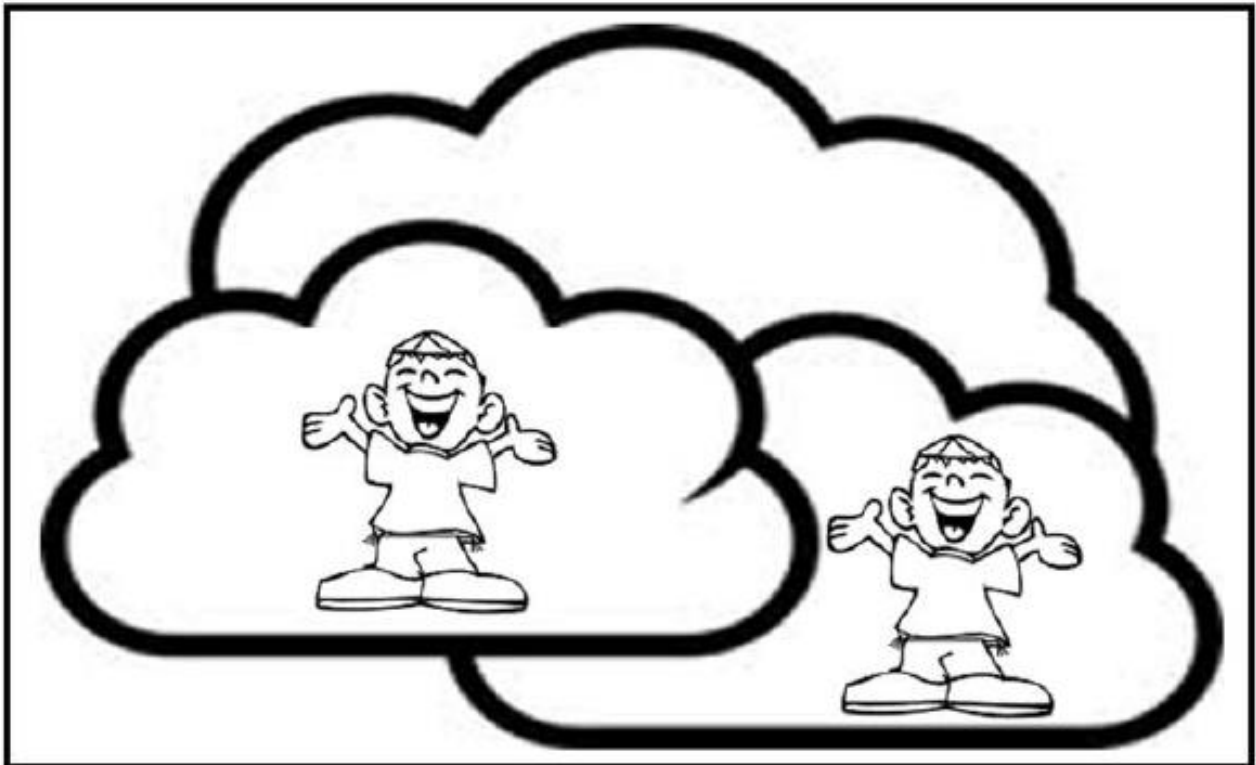
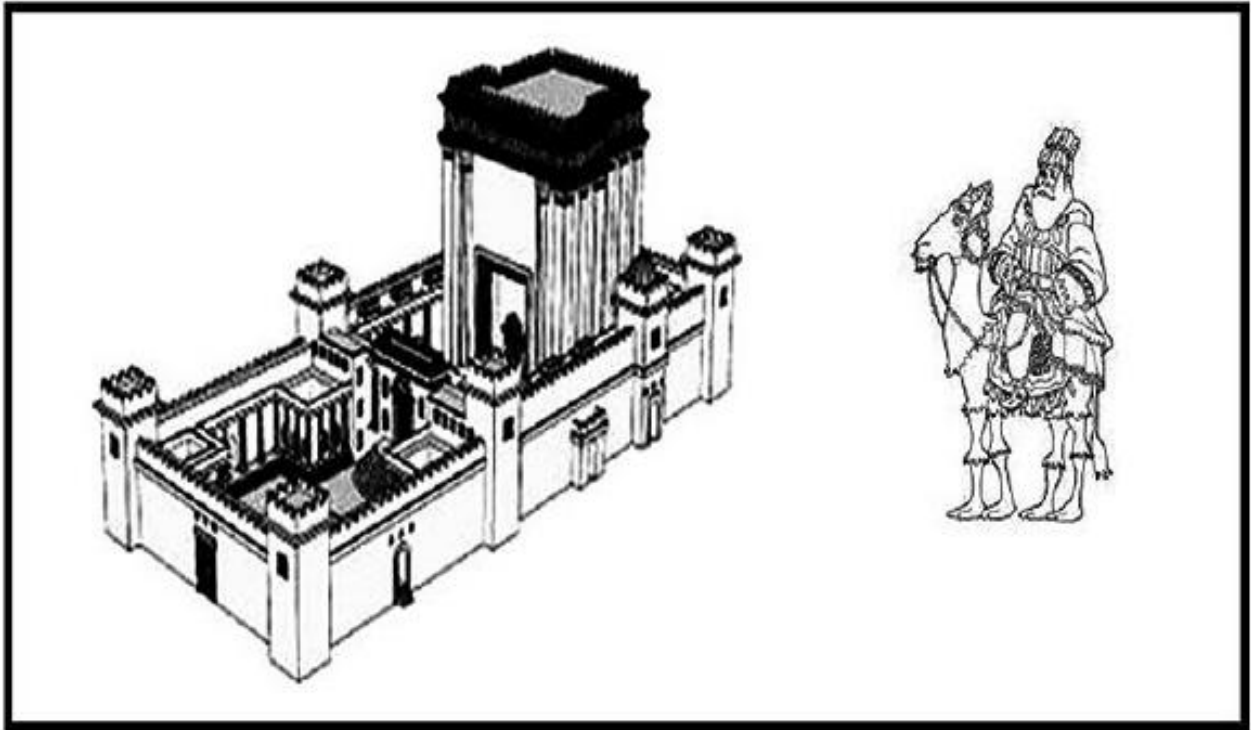

**We will all understand, it will be clear as day,
That Hashem fills the world in a very hidden way.**



And everything that happens, no matter where or when,
Is all being done by no one but Hashem.

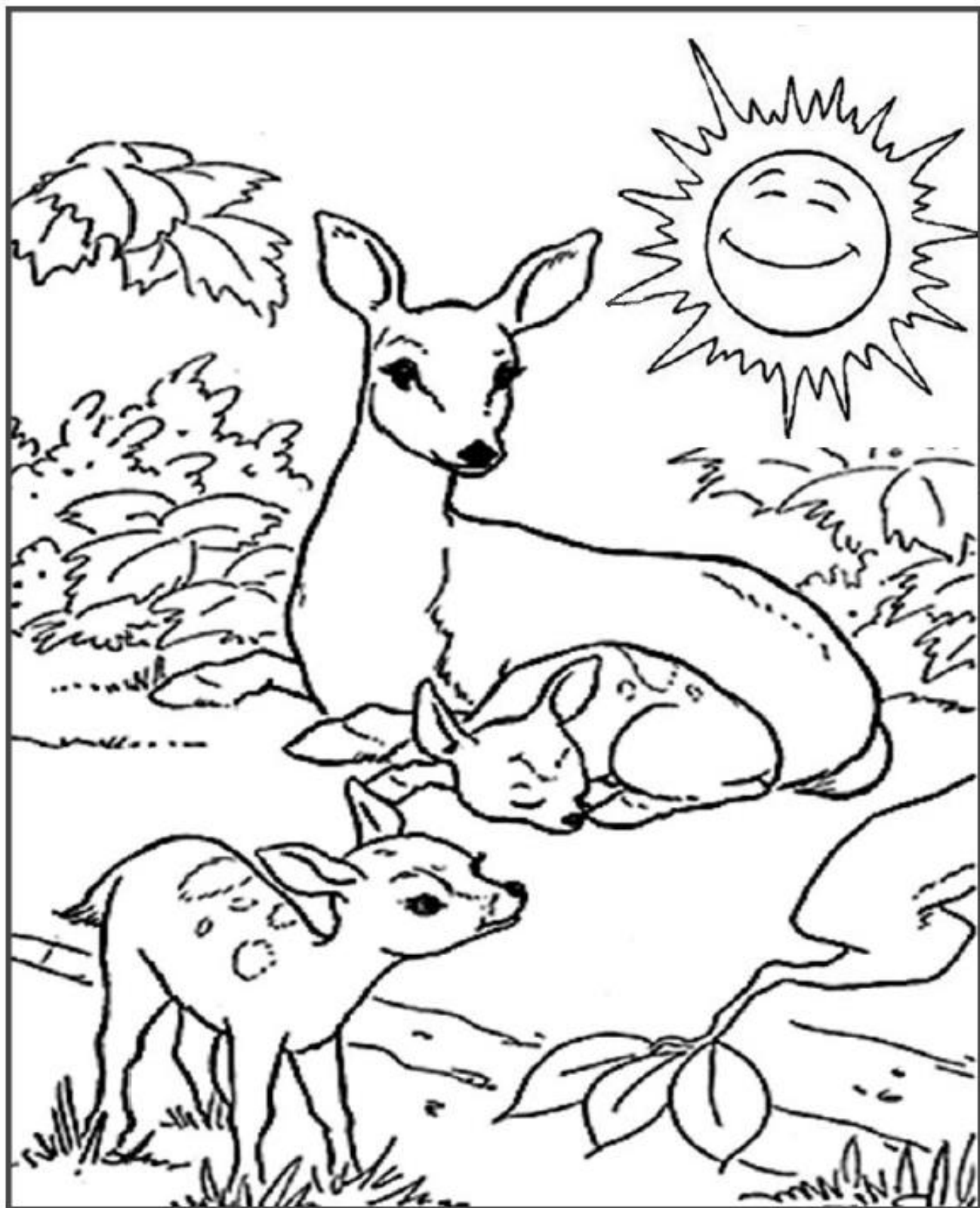

Our prophet Yeshayah said the day will arrive,
When the world will understand, and open its eyes.



Hashem fills the world -- everyone will know

Like the water covers the sea-world below.”

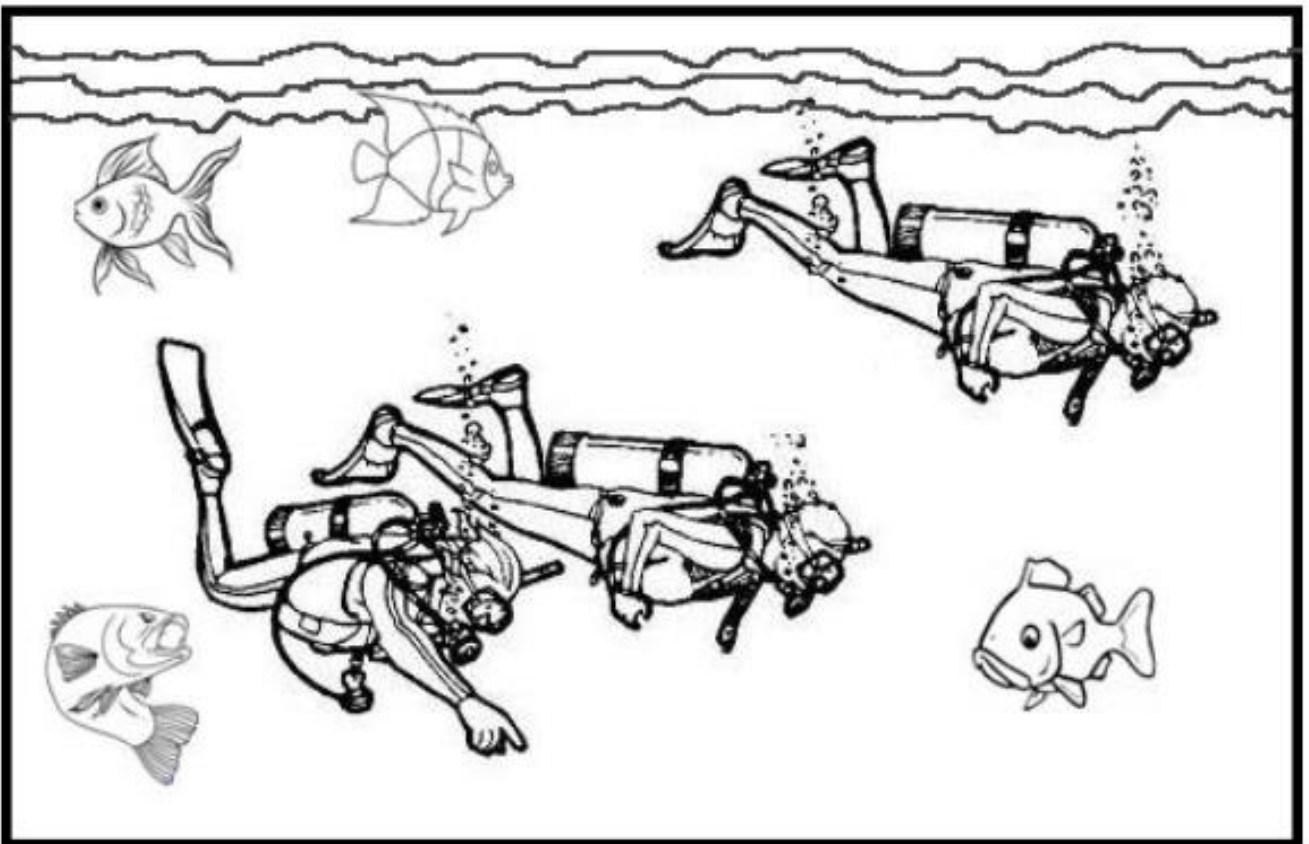
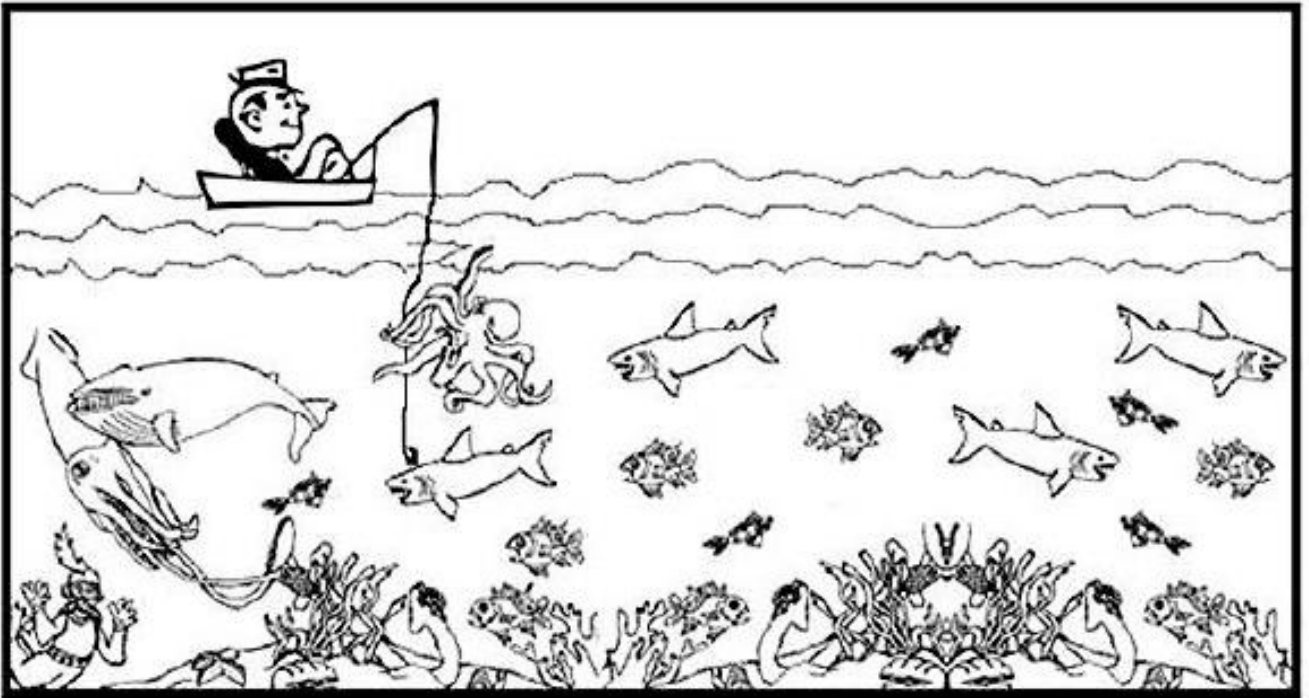

“But Tatty, who will teach us” asked Chaim and Tzvi

“To open our eyes so we’ll all start to see?”

“Moshiach”, answered Tatty, “will teach and explain
The knowledge of Hashem, may he come now, Amen!”

בשעה שמלך המשיח בא
עומד על גג בית המקדש
והוא משמיע... ואומר
ענויים הגיע זמן גאולתכם!



